

In This Issue





- *A Slightly Different Approach..* pgs 1,3
- *Pres. Message: "It's Holiday Time"* Pg 2
- *Subsonic Air Flow Over a Wing Surface* Pg 4
- *November Meeting Minutes* Pg 5
- *Weighing an Aircraft* Pg 6
- *Ads and Upcoming Events* Pg 7
- *The Original Home-built* Pg 8



December 15, 2007 Meeting
"Christmas Party"

22 Hawthorne Dr. Valley Center
Doug Moler's Hangar, High Point (3KS5)

Directions to the Christmas Party

- Take I-135 N / US-81 N / KS-15 N toward SALINA.
-  Take the 85TH STREET exit- EXIT 17. 0.2 miles
 -  Turn LEFT onto E 85TH ST N. 1.5 miles
 -  Turn RIGHT onto N SENECA ST. 0.1 miles
 -  Turn RIGHT onto HAWTHORNE DR <0.1 miles
 -  End at **22 Hawthorne Dr**
Valley Center, KS 67147-8585, US

Please bring a side dish or a dessert

*A Slightly Different Approach
to a Roadable Aircraft*

What has 22 HP, four wheels, drives on the road and flies through the sky? Well, there might be a handful of answers to that question, but if you add that it has 7,500 HP for flying, carries three, has on board chillers for BOTH white and pink champagne, and folds to fit in the back of a Volvo wagon, the list narrows to a single craft, Ron Pagoris' experimental balloon "Screwball". In Ron's own words: "First and foremost, "Screwball" is a flying machine. Yes it's fun on the ground, but it's in the air at every opportunity. When it is on the ground, fun stuff though. Everything works. When I land, I can pack up the balloon envelope, put it on the back and drive off while carrying 3 people. I built the puny little burner in 1985. I needed something light when driving. I used 36 feet of Inconel 600 3/8" X .035" wall tubing. IT PRODUCES 30,000,000 BTU's!!!

(Continued on pg 3)





President's Message...

It's Holiday Time.....

Today is Black Friday, shopping day. Not for me as I'm kicking back to let the Thanksgiving dinner continue to settle.

In 2005 I took our grandson who had soloed shortly before to Air Adventure (Oshkosh) for his first time. He is a ATC tower operator stationed at Offut AFB. Last evening as the turkey was being served he and his wife came in. He had rented an Arrow from the base flying club and is spending Thanksgiving with all the local relatives. He has his tailwheel endorsement and will complete his instrument training next month. Great going Alex.

For those who didn't make the Nov. mtg. you missed a really good one. Thanks Neal.

See you all at the Christmas dinner. Bring a side dish that goes with Brisket or Ham, if you wish your favorite Holiday dessert also.



The consequences of opening military airways to commercial operations were more far reaching than originally foreseen....



Chapter Officers

Jim Smith President
planehouse@hotmail.com
316 776-9912

Don Herbel Vice-President

Gary Moore Secretary
mooreforless@hotmail.com
620 837-4876

Ed Scott Treasurer

Paul Fiebich Program
Fiebichpv@aol.com 316 777-7984

Bob Blanton Fly-Ins
juneblanton@hotmail.com
316 683-9759 (corrected)

Rick Girard Newsletter Editor
jindoguy@gmail.com 620-782-3854

Chuck Powell Young Eagles
chuckpswoop@aol.com
316-778-2056

Ken Rathbun Young Builders
316 267-2504 (H) 208-9236 (C)

Larry M. Tener Tech Counselor
larry_tener@sbcglobal.net 316
-776-2038

Jim Smith Flight Advisor
planehouse@hotmail.com
316 776-9912

Linda Tangen Webmaster
webmaster@eaa88.org
316 636-4003

Richard Kirkland Youth Coord.
R-d.kirkland@global.net
316 682-7814

The Beacon is published monthly by the Experimental Aircraft Association Chapter 88 of Wichita, Kansas. It is for the use, education and enjoyment of Chapter members and others to whom it is provided. Accurate information transfer is our goal, however the reader should verify information and contacts prior to attending an event.

Membership dues are \$15/year pro-rated at \$1.25/month for new members starting in August. Send your dues and membership form to: EAA CHAPTER 88, PO BOX 780833, WICHITA, KS 67278-0833.

Chapter meetings are held at 7:30 PM the third Saturday of each month at the Kansas Aviation Museum on 3350 S. George Washington Boulevard, Wichita, Kansas.

The Beacon newsletter is published monthly and distributed one week prior to each meeting. Article submission deadline is the first Saturday of each month. The editor reserves the right at his/her discretion to edit all submitted materials. Accompanying e-mailed photos should be sent in either JPEG or Bitmap format. U.S. Mailed photos will be scanned and returned to the sender at the next regular Chapter meeting.

Address submissions to newsletter Editor Rick Girard, 8475 Kansa Ln Udall, KS 67146 (620) 782-3854 or jindoguy@gmail.com. Other Chapter newsletters may borrow The Beacon's content provided proper credit is given to the source. Unless so noted, photos are the editor's.

It has 13 strategically adjustable aim jets to minimize noise at the passenger level. While a commercial burner uses 1 lb. of propane in a 4.3 second blast, this beast uses 3 lb. It locks in position for ground ops and produces a very tight, blue flame. Even compared to today's standards, it is right there.



Tuning the burner for altitude was something else, again. In its initial iteration, it quit at ~12,000 feet. When the next test was made, I brought along a roll of Reynold's Wrap and tried various configurations of a cowl between the burner can and the coils. With this modification I was able to adjust the flame better and get it to over 16K.

Let me tell you, oxygen or not, if you are doing physical work at altitude, not just sitting complacently, it brings on hypoxia a lot quicker. After that flight, I made up a cowl out of stainless steel sheet stock. It works great, and has been trouble free ever since.

During certification I loaded up my balloon trailer and lifted 2750 lbs. I usually like to fly Screwball at 15 pounds per thousand cubic feet of envelope volume. It flies okay even at 20, but at 30 it's a dog. Besides it's a real drag having to carry tank-age when it's empty.



Unlike a traditional basket, I can't position my nose downwind all the time by just walking around the basket until it is. Thus, I incorporated turning vents. One right turn and I left. They are 12 foot long and begin at the equator and extend up. The top of balloon, at 20 pounds per thousand feet, is only loaded at .008 pounds per square inch. It may not sound like much, but there are a lot of square inches there.

At equilibrium that equates to a turning rate of 2 RPM at about 15 pounds or more per thousand. When fully filled the balloon is 56 feet in diameter, and probably 75 feet or a bit more tall.

For ground pounding, the bathroom "motif" is both fun and functional. Handicap grab rails are perfect for lifting and it breaks down to 30+1/4" tall for transport.

Since the most precise way to know how much fuel is in a Worthington cylinder is to weigh it, the rear seat is an oak bathroom scale. As for the pilot and co-pilot seats, well, oak and wicker is traditional. They both fold and are plenty comfortable.

There's a bathroom faucet on the front. It's traditional to have a bottle of champagne handy on landing to take the edge off a hostile landowner. After getting hot and sweaty packing up the balloon envelope on a hot summer day, opening up a bottle and taking a sip is welcome, but it's not meant to be warm brew that pushes bubbles out of your nose.

Propane is a cryogenic liquid, let it boil and it wants to seek about -42 degrees F below zero on a standard day at sea level. A pretty good and handy refrigerant! Thus, I have two, make it yourself, seltzer bottles. One white and one red. One contains a quart of white champagne, and the other a quart of pink. I have some .035" wall copper tubing wrapped around the bottles, and used some thermal conductive compound, have a .035" orifice and run propane through it. I open a valve and 3 minutes later, I have champagne perfect for drinking! I have an on-board mini air pump, and 40psi is just enough to dispense chilled champagne, both pink and white through the bathroom faucet. On the port front, there are 4 black Mikasa long stem champagne glasses to drink from. I purchased spares when I bought them in 1985 from Fortunoffs, but we're still flying with the originals.



When I began working on the gondola, the closest thing at that time, to what I wanted was a Honda Odyssey, which weighed in at 450 lb. without any provisions for tanks, burner and associated things to fly, and only carried one person.

Screwball's gondola weighs in at 140lbs drivable and carries 3 people. Flight ready, with 31 gallons of propane on board it weighs 600lb.

Screwball has over 200 hours flying time thus far, and her longest flight to date is 7 hours and 15 minutes."

Thanks to Ron for the story and photos of Screwball.

Subsonic Air Flow Over a Wing Surface

By Harold Waltner

The following article was published in an issue of the OX5 Aviation Pioneers national newsletter. The article was written by Harold Walter, National President of the organization.

Editor's note: Big thanks to Harold for sending in this article!

The basic air flow over a wing described here assumes a smooth wing with a conventional airfoil shape, such as the NACA four digit basic contours used on wings and tail surfaces of many Cessna, Beech, and other airplanes. For the following comments, consider the air flow to be chord-wise, on a smooth and un-flapped airfoil.

Three basic low subsonic types of chord-wise airflow occur over the wing. They are laminar, turbulent, and separated. Assume a low angle of attack, such as at cruising speed. On the lower wing surface, laminar flow typically occurs from the leading edge to, or near, the trailing edge. The upper surface generally has laminar flow back to approximately the maximum wing thickness point. At higher wing angle of attack values, the aft location of laminar flow on the upper surface moves forward.

For this same angle of attack condition, turbulent flow begins just aft of the laminar flow on the upper wing surface near the thickest chord-wise location. At higher angle of attack values turbulent flow begins more forward. Separated flow occurs very near the wing trailing edge on the upper surface.

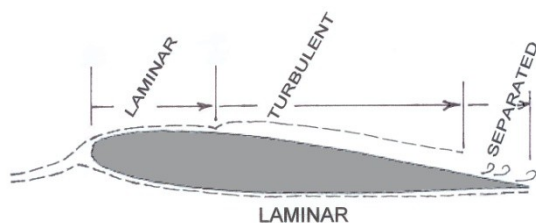

FLOW CHARACTERISTICS IN CRUISING FLIGHT

The local surface aerodynamic drag associated with these air-flow types varies. Laminar flow provides the lowest drag and turbulent flow has approximately double the drag of laminar flow. Separated flow drag is very high, but for low angles of attack occurs over only a small area near the wing trailing edge. It would seem that it is desirable to have all laminar flow. However, turbulent flow decreases the amount of separated flow, so that it is desirable to have some turbulent flow in order to minimize the amount of separated flow.

In summary, for low drag, laminar drag is desirable, but some turbulent flow is also needed in order to minimize the amount of separated flow, since separated flow creates very high drag. Tufts applied to the wing surface can give us a clue as to the type of existing airflow. However tufts affect the airflow somewhat. Tufts that lay flat with no movement imply laminar flow. Tufts that lay on the surface, but oscillate indicate turbulent flow. Separated flow is the most obvious, and causes tufts to rise above the surface and they may curl forward.

In addition to tufts, oil flow is sometimes used to show the airflow characteristics. A few years ago, Dr. Bruce Holmes of NASA Langley created a mixture of chemicals, which could be sprayed on the surface without affecting paint, etc. The coating provided a smooth translucent finish that could be visually observed. Turbulent flow caused a rapid sublimation of the coating, quickly removing the coating from the surface. Laminar flow sublimed the coating very slowly, and remained on the surface for a long period of time. A comparison of the two areas could readily be examined after flying the airplane. The airplane was flown at a constant airspeed for about a half hour after spraying, and the area where laminar flow existed could readily be noted.

This test was applied at Beech Aircraft on a Beech Sierra. The results were quite interesting. There was a lot more laminar flow than what would normally be expected, or at least more than I expected. It could be noted that the smallest particle near the maximum airfoil thickness location caused turbulent flow to be initiated. Particles near, or on the wing leading edge did not cause a noticeable amount of turbulent flow. A particle near the leading edge might cause a small turbulent bubble, but the flow in that area would immediately returned to laminar. Very small surface particles near the maximum airfoil thickness caused turbulent flow. Looking at the airfoil surface from above the "V" emanating from the particle was quite apparent. I had asked Bruce Holmes to spray the propeller, also. I wondered if the high speed of the propeller might cause premature sublimation even though the flow might be laminar. The effect on the propeller was like that of the wing.

In summary, Bruce Holmes spray-on liquid is good for showing laminar flow areas, and tufts are good for noting separated flow regions. Reading the results in detail is a strong function of experience.

Emergency Locating Transmitters

121.5 or 406

From Don Herbel

It might be of further interest to the Chapter members to expound on the 406 mhz ELT situation that Jim Smith brought up at the last meeting, Saturday, November 18th.

According to the NOAA, the federal agency in charge of the earth satellites, the SARSAT will no longer monitor ELT signals from the 121.5 band after Feb 2009 as I stated. However, I also mentioned the 406 transmitters are not being mandated by the FAA, at this time. If an aircraft owner chooses to stay with the 121.5 ELTs, he will only be monitored by other aircraft or ships that are in his range. More information can be found at <http://www.sarsat.noaa.gov/faq.html>

What's Wrong Here?

Take a minute and have a look at this video. What do you think?

http://www.metacafe.com/watch/738998/ballistic_chute_deployment/

CHAPTER 88 MEMBERS MEETING NOVEMBER 17,2007, KAM, 7:00PM

President **Jim Smith** welcomed all and recognized 3 visitors: **Kate Herbel, Ken Rodgers, Robert Ringer.** Treasurer **Ed Scott** reported Old Balance:\$7596.72, Deposits \$30.,Expenses:\$253.89,New Balance\$7372.83

Jim passed on a story of a 30hr Vari-eze that lost power soon after rotation. Cause: Mud-dobbers built their nests in the uncapped fuel tanks during construction and eventually clogged the fuel filters. Always cap fuel tanks, pitot tubes, exposed rib lightening holes to keep out insects and rodents.

Jim explained the new \$10 EAA Jr. membership, till age 17 yrs., and Ford Motor Co. discount coupon.

Jim announced the chapter positions of Young Eagles coordinator, Program chairman, and web master needed filling with some popping hands. **Leon Stefan** wanted Young Eagles coordinator position and **Paul Fiebich** grabbed Programs. The new 2008 EAA calendars are \$15.00 from treasurer **Ed Scott**

Steve Waltner announced he received his fixed-wing rating and flew solo over Benton airport last week.

Jim led a discussion about the ELS 2009 rules. **Jim** related an out of date aviation magazine give-away at the Kalamazoo Aviation Museum gift shop. Maybe that idea is something we might ask the KAM museum.

The discussion about magazines continued with the reminder that past Sport Aviation is available on CD's.

The chapter Christmas party will be Saturday, Dec.21, 6 PM at **Doug Moyler's** new hanger, High Point.

Rich Girard said directions would be in the December newsletter. The chapter supplies the drinks and meat (brisket and ham) and members bring desert, side dishes and salads.

Jim mentioned that an aviation researcher, Libby Culpepper, from WSU has a project for older pilots, she needs volunteers. Some members said they were participants.

Jim announced that Richard Kirkland was at Via Christi hospital, room 8060, recovering from colon surgery.

Paul Fiebich announced he took his first powered para-chute ride for a REALLY SLOW flight.

Neal Wolford, project engineer from Cessna, gave the evening program about the LSA 162 Sky Catcher. He used a power point on **Steve Waltner's** laptop and answered many questions afterward.

The door prize winner was _____ and received a gift certificate from the Aviators Attic.

Meeting adjourned at 9:00 PM.

Next ERT meeting Nov. 26. Next members meeting Dec.15.

Respectfully submitted, Gary Moore, Secretary



Third Friday of Each Month!
Commemorative Air Force Jayhawk Wing

December 21st. Doors open 6:00p.m.Movie starts 7:30
Commemorative Air Force Jayhawk Wing Hangar
2560 S. Kessler, Wichita, KS.

Finish your Christmas shopping and watch a movie, too

Help Support your local CAF Wing

Weighing an Aircraft

or, A picture really can be worth a thousand words

By Rick Girard

You can find almost anything on the web, unfortunately there is no truth detector to let you know if the information is worth the electrons it's conveyed by, or not. Case in point was a recent discussion on weight and balance on a forum I belong to. The forum is type specific to the Kolb series of pusher taildraggers and the topic was how to properly weigh the aircraft.

One of the members offered the view that it made no difference whatsoever whether the aircraft was placed at the proper angle for weighing. There was a long string of responses, some not too kind, expressing a differing view, along with explanations of varying clarity. My first take was that this is a simple trig problem that didn't need much in the way of explanation. As the topic dragged on and positions became more and more entrenched it became obvious that it was something less than simple and I began looking for a way to make it crystal clear that positioning the aircraft properly was vitally important. I have to admit that the muddle was making my own picture of the process a bit confusing. I had a picture in my head that made perfect sense to me, but translating that to words was proving illusive. It hit me after the third day or so that there was no reason to translate the picture in my head, I just needed to draw it.

I opened my CAD program and began making lines and in less than an hour or so I had a nice looking stick airplane that represented the general Kolb layout in enough detail to illustrate the point I wanted to make. CAD being the excellent tool that it is, I had only to make a copy of my stick airplane immediately above the first with the tail raised to the weighing position specified in

the plans, that being 9 degrees measured on the bottom surface of the wing, so I could show the difference between the two. Like most pilots trained since the advent of nosedragger trainers, I picture the aircraft sitting on it's gear just as the Pilot's Operating Handbook shows it. It was only when I looked at my stick airplanes that I saw how difficult it was to put into words what happened to the datum of the Kolb when it was rotated from sitting position to weighing position. It moved.

Worse yet, the lengths of the arms from the datum to the tailwheel and the variable components changed. The Cessna picture in my head didn't comprehend to that at all. The words I was using to explain why a Kolb weighed in sitting position would be tail heavy in flight were based on the movement of the tailwheel weigh point as the aircraft was raised, which as I could clearly see was rather small, not that the variable components, pilot and fuel, AND the datum would move, too, and that movement would be rather large. Clearly, weighing the aircraft in sitting position caused the arm measurements from the datum aft to shorten and those forward of it to lengthen. As a result the aft moments would be smaller, while the forward moments would be larger and the CG would calculate to be further forward than it really is. If calculations based on the incorrect position were near the aft limit, once the aircraft was flying the ACTUAL CG would be aft of the limit and the pilot would find himself with at best a squirrely handling plane, and at worst, should it depart from controlled flight, a potential death trap.

So, I posted my sketch with an explanation similar to that above. The pilot making the spurious claim had an AHA moment and the forum got on with its business. Thousands of words had been expended, but a simple picture got across the point to him, and gave me a better understanding, too.

Ideal CG ————
Datum ————
Pilot CG ————
Fuel CG ————
Tailwheel ————
Main Gear ————

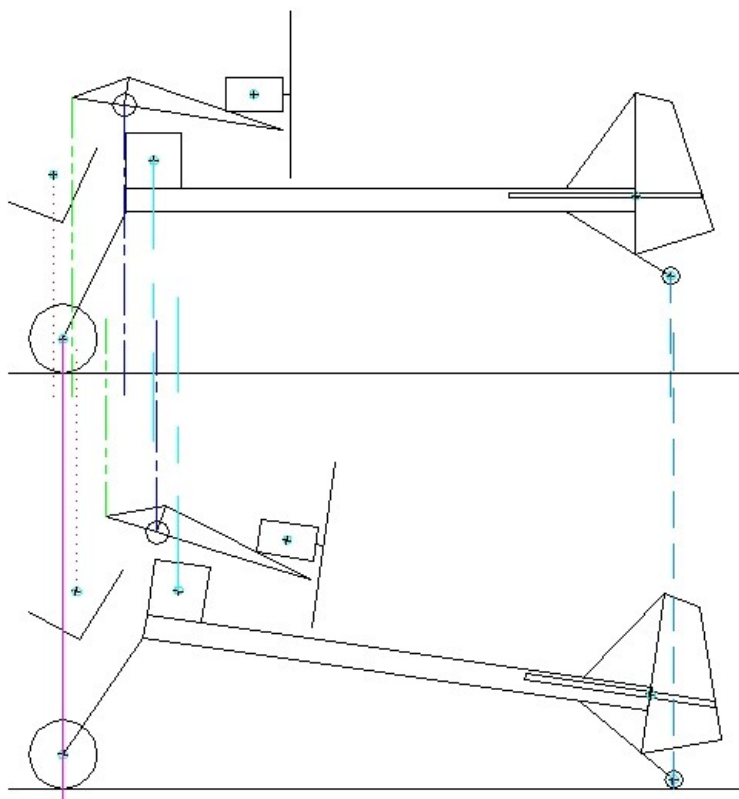

Announcements & Items for Sale or Rent

Information / Leads Wanted

I am helping a fellow (Jerry Yagen) <http://www.fighterfactory.com/> locate World-War-One era engines/airframes or replicas.

Hispano-Suiza, Mercedes, Hall-Scott, Liberty, OX-5, Siemens-Halske, Oberursel, Clerget, LeRhone, Gnome, other rotaries, etc. If you know of anything for sale / trade I'd appreciate any information.

Russ Lassetter
EAA# 0448996
Cleveland, Georgia
rblassett@alltel.net
706-348-7514

For Sale

Gerdes 4" nose wheel. New. \$60

Rick Girard
620-782-3854

For Sale

"Modified Stewart Headwind"

Always hangared and maintained in flying condition. Single place with 1835cc VW engine. Cruise at 80 mph on 3 gph auto fuel. Come see it and make an offer.

Dick Geide (316) 684-0884

Calendar of Events

Check the Chapter website at eaa88.org for posters of listed events

- Dec 15** Chapter Christmas Party
Doug Moler's Hangar
High Point
- Jan 19** Winter Chili Feed
Wings of Remembrance
Committee
Newton (EWK)

The editor's project

Or, Since I had some space to fill



While browsing the aisles at Ace Aviation Supply I found the perfect overhead panel for the Kolb. Once I got it laid out and drilled, I put in the mag and starter switches to see how everything fit. Now to drill the rivet holes and mount it.



New radiator and plumbing for the Rotax 582. The radiator is from a Honda Sabre 750 motorcycle and replaces the dual Rotax setup. I had a radiator shop rework the outlets and add another for the steam vent line from the head. Unfortunately the shop couldn't make the outlet smaller than 5/16", hence the reducer.





*A homebuilt version of the original homebuilt flies at Huffman Prairie
A Merry Christmas to All and to All a First Flight*

EXPERIMENTAL AIRCRAFT
ASSOCIATION
JAYHAWK CHAPTER 88

This is a
stamp
frame

Richard Girard
jindoguy@gmail.com

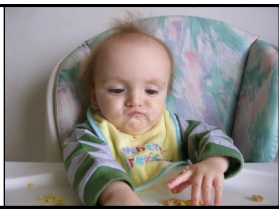

The Leader In Recreational Aviation

For they had learned that true safety was to be found in long previous training, and not in eloquent exhortations uttered when they were going into action.
Thucydides, circa 404 BC

This is an address frame, the printing company will place an address label here

**We're on the web:
www.eaa88.org**